



Handicare Ceiling Lifts

Safe and Easy Patient Transfers

C-Series Ceiling Lifts

A good ceiling lift does two things: goes up and goes down, safely and reliably. For more than a decade, the Handicare C-Series lift has established an industry-leading reputation for reliability. Reducing injuries for patients and caregivers alike, **the C-series has safely moved thousands of users, at a price that has set the standard for value in the industry.**



The Reliable Choice for Safe and Easy Transfers

Versatile & Robust

The Handicare C-Series ceiling lift is available in a full range of lifting capacities to meet virtually any lifting need—from the 450 lb lift suitable for many patients up to our 1000 lb lift for bariatric patients. Handicare also provides state-of-the-art, customized ceiling track systems that transport a patient from a bed to a chair or bathroom, and even to another room or area in your facility.

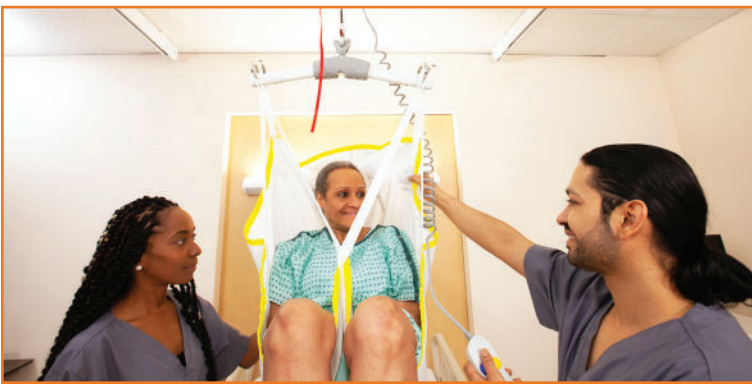

● Lifting & Transfer



● Turn & Reposition



● Support & More

C-Series Hand Control

Safe, reliable and *always ready*



Intuitive Design

Quiet and smooth, our compact C-Series ceiling lifts feature a pneumatic hand control that has no electrical components for additional safety. The large buttons make it easy to operate the lift with clear directional indicators.

Digital Display

The C-Series features an easy to read digital display underneath the lift that provides critical information such as: Number of Lifts, Battery Life and Lift Status.



C-800/1000 for your Bariatric Patients

A Powerful Lift in a Small Package

Handicare's bariatric ceiling lifts make it possible for caregivers to safely lift and transfer patients of all sizes with respect and dignity. The Handicare C-800 and C-1000 are the smallest and strongest, single-unit bariatric lifts in their class weighing approximately 24 lbs (10.9 kg).



Easy Service

Servicing the C-Series Ceiling Lift has never been easier, the bottom cover can be removed for quick maintenance. Swapping in a new battery can be done while the lift is still on the track, eliminating downtime for your staff and patients.



A-Series Ceiling Lifts

Built on the proven technology of the Handicare C-Series, the new A-450 and A-625 ceiling lifts raise patient handling to the next level. Increase patient protection with antimicrobial materials. Simplify patient transfers with its tilting design. Easily access real-time data and diagnostics.

Handicare's A-Series ceiling lifts give you the advantage in safe patient handling.



Antimicrobial Strap with Wear Indicator Marks

The **advantage** of reduced risk

Active Shielding

In medical environments, microbes proliferate. Protecting patients from infection that can spread like wildfire is a challenge every healthcare facility faces. Handicare A-Series ceiling lifts provide you one more shield against infection for your patients.

Microbe Growth: Untreated Strap vs. A-Series Strap

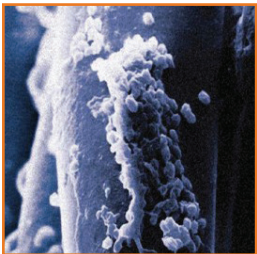

Microbe growth on untreated strap fibers

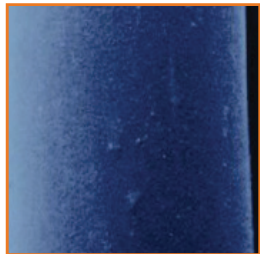

Growth on treated Handicare A-Series strap fibers

Easy Maintenance

Easy to clean and disinfect, A-Series lifts include a strap that has been treated with a specialized antimicrobial coating at the fiber level. The coating inhibits microorganisms' ability to grow on the surface of the material, thereby reducing the risk of infection while improving both safety and outcomes for patients.

Monitor Wear

Our lift strap also features wear indicator marks so you know when it needs to be replaced. And its reinforced edges protect against fraying and normal wear-and-tear to enhance the overall life of the strap.

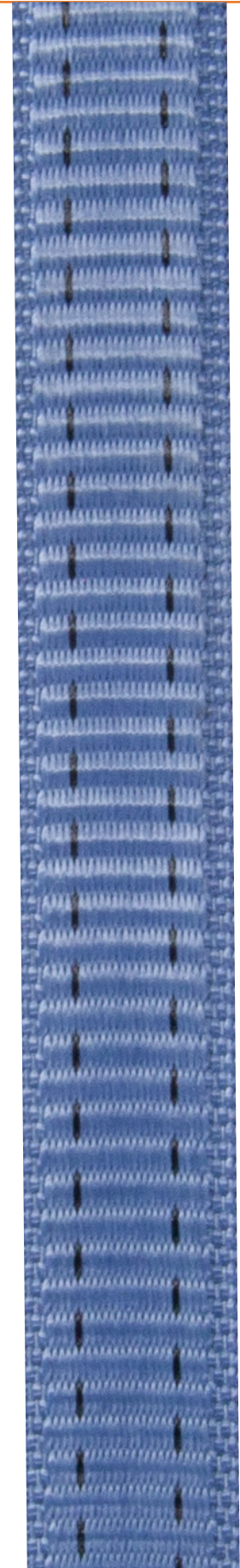

Hand Control with Active Status Display

The **advantage** of real-time feedback

Intuitive Design

The A-Series hand control puts all lift data, diagnostic, and movement information right in the palm of your hand. The full color backlit display makes the hand control easy to read while waterproof technology protects the unit from outside moisture.



Three Operating Modes

More than just operating the lift, the A-Series hand controller helps you gather and record weight information for a patient while simultaneously collecting data on the lift's use and performance.

- 1 Control
- 2 Weighing
- 3 Data Collection

Tilting Design with Quick Serviceability

The *advantage* of efficient positioning

Easy to Handle & Maintain

The Handicare A-Series ceiling lift is able to tilt up to 15° degrees, saving time and frustration during a transfer by getting the patient parked in the right place in the least amount of time. This also enables less strain on the lift strap as well as the caregiver.

The A-Series ceiling lift can be taken off the track without removing end stops and end caps making servicing extremely easy. While simple fixes such as battery swaps can be done right on the track.



15° Degree Tilt ●

A-Series Power in a Portable

The Handicare AP-450 gives you all the benefits of the A-Series in a portable version. Lightweight and easy to use, the AP-450 portable ceiling lift can be removed from one track and installed in another, giving you the freedom to share a single lift unit in multiple ceiling track systems in multiple rooms.



Our Slings

Trusted by millions for safe patient transfer

The Most Complete Sling Assortment Available

Handicare is your trusted slings provider. With over one million slings manufactured worldwide, we offer the most comprehensive line of shapes, sizes and materials that can be used with any ceiling lift.

From simple to the most complex transfers, Handicare slings are designed to aid caregivers and provide a solution for every type of transfer.



Comprehensive Selection

Slings for Any Situation

Ask your Handicare Sales Rep about our complete assortment of slings that include:

Hammock, Hygiene, Positioning, Universal and Speciality Slings available in a wide variety of materials and sizes for both children, adults and bariatric patients.



The Right Carry Bar for Every Transfer

The **advantage** of the right tool for the task

Multiple Sizes

The proper carry bar is essential for safe and comfortable lifting. Handicare offers a wide range of carry bars suited to most every situation, including: bars fitted with bull horn connectors or spring latch connectors; narrow bars for small patients such as children; and wide bars for bariatric and pain-sensitive patients; and bar configurations that have two-point and four-point sling bars.

Our Quick Release System (QRS) makes attaching or removing a carry bar a snap - literally. Having the right carry bar installed for any situation or user has never been easier.



Carry Bar Models & Options



Carry Bars - Spring Latch Connector:

with Strap

360987: 14.0 in (355 mm)
360986: 18.2 in (461 mm)
360985: 21.6 in (550 mm)

with Quick Release System (QRS)

360983: 14.0 in (355 mm)
360982: 18.2 in (461 mm)
360981: 21.6 in (550 mm)



Carry Bars - Bull Horn Connector:

with Strap

360937: 12.8 in (325 mm)
360936: 16.7 in (425 mm)
360935: 20.7 in (525 mm)
360934: 26.4 in (670 mm)

with Quick Release System (QRS)

360933: 12.8 in (325 mm)
360932: 16.7 in (425 mm)
360931: 20.7 in (525 mm)
360930: 26.4 in (670 mm)



Carry Bars - Speciality:

with Strap

360760: Easy Swivel for C-625
360936: 2-point for C-1000 - 20.5 in (520 mm)
360935: 2-point for C-1000 - 26.4 in (670 mm)
360934: 4-point for C-1000

Handicare Ceiling Tracks

Create Paths to **any Room** for Patients

Track Systems for any Space

A flexible, customizable solution for any space, a ceiling track system is a safe and reliable way to provide access throughout a single room or even multiple rooms.

Handicare ceiling lift rail is made from powder-coated aluminum. Offered in straight and curved sections, it's available in six profiles to meet the needs of any installation

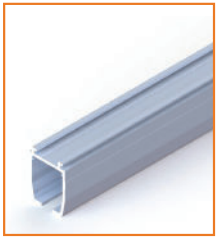

Regular Track
Standard rail for most applications.



Flush Mount Track
For the lowest-profile installation.



Super Track
Heavier rail for longer free spans between attachment points.

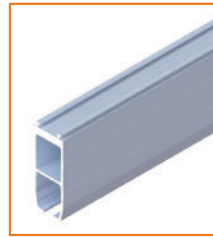

TrackPlus
Our highest rigidity track for our longest free spans.



Quick Curve
The smallest curve in the market only offered by Handicare to address tight corners and obstacle avoidance with a 6.5 in (165 mm) radius.



Curved Track
With three angle options (22, 45 and 90 degrees), provides endless room layout options and is available in both standard and flush mount.

Multiple Charging Options Available

The Handicare A-Series and C-Series ceiling lifts are available with Constant Charge and Return to Charge options. Constant Charge provides charging anywhere the lift is on the track while Return to Charge provides a designated area on the track for charging.



Track Accessories

TurnTables

TurnTables are circular plates that enable multiple exit points so that your Handicare ceiling lift motor can go in different directions. Handicare TurnTables enable up to 14 possible angles for exit points and come in three models: Power, Manual and QuickFit.



Transgates

When room and bathroom coverage are a priority in acute patient or long-term care resident rooms, Handicare Transgate mechanical devices enable your ceiling lift motor to traverse from an X-Y room covering system to a fixed, straight rail or vice versa.

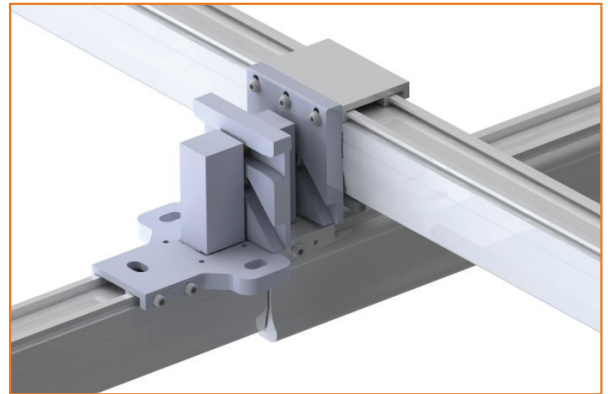

Proprietary Smoke Control & Odor Prevention System

Handicare has developed a new solution to prevent any potential smoke or gases from escaping through our ceiling track system. It's a proprietary design that seals the gap in the ceiling track where it passes through a fire door. The Handicare ceiling track smoke control system is a spring-loaded mechanical device enabling seamless transfer of the ceiling lift when traversing through the doorway.



Compatible with Existing Ceiling Track - Whatever Track It Is

Retrofitting Made Easy

Have a ceiling lift system in place but want to change the lift unit and keep your track? No problem with Handicare.

With most brands, if you change the lift you have to reinstall the entire ceiling track system. Handicare ceiling lifts work with virtually any manufacturer's ceiling track, saving you headaches and expenses.

Upgrading to Handicare's safety and reliability is as easy as popping the old lift unit out and dropping your new Handicare ceiling lift.



A-Series Modular System

The A-Series unique Modular System simplifies the retrofitting process. Simply choose your Lift, Trolley, Carry Bar and Hand Control to complete your A-Series selection.



C-Series Specifications

Motors

Lift Motor: 24 VDC
Power Traverse: 24 VDC (Opt)
X-Y Traverse: 24 VDC (Opt)

Safe Working Load (SWL)

C-450: 450 lb (204 kg)
C-625: 625 lb (284 kg)
C-800: 800 lb (364 kg)
C-1000: 1000 lb (454 kg)

Dimensions (L x W x H)

C-450 / C-625:
12.5 x 8.6 in x 5.7
(317.5 x 218.4 x 144.8 mm)
C-800 / C-1000:
13.1 x 10.2 x 7.5 in
(332.7 x 259.1 x 190.5 mm)

Unit Weight

C-450 / C-625: 24 lb (10 kg)
C-800 / C-1000: 24.5 lb (11.1 kg)

Lift Case

Flame Retardant ABS

Safety

Emergency Stop
Emergency Lowering Device
Emergency Manual Lowering

Standards

IEC 60601-1:2005/A1:2012
IEC 60601-1-6:2010/A1:2013
IEC 60601-1-11:2015
IEC 62366:2007/A1:2014
ISO 10535:2006
IEC 60601-1-2:2007
VL 60601-1.2003

Hand Control

Pneumatic

Service Life

10 Years or 22,500 Cycles

Rated Performance

C-450: 50-60 lifts at 450 lb
C-625: 30-40 lifts at 625 lb
C-800: 17-20 lifts at 800 lb
C-1000: 17-20 lifts at 1000 lb

Batteries

AH, Sealed Lead Acid
24 VDC (2 x 12 VDC)
5.0 AH

Charger Model

Soneil, PS2403SRM30

Charger Input

100-240 VAC, 50-60Hz 1.5A

Charge Output

24 VDC, 1.0 Amps

Lifting Range

Up to 82 in (2082 mm)

Duty Cycle

1 Min "On"
9 Mins "Off"

Part Numbers



C-450: Lift Up to 450 lb (204 kg)
323100: Manual Traverse (Docking Station)
323400: Manual Traverse (OMNI Charging)
323150: Power Traverse (Docking Station)
323450: Power Traverse (OMNI Charging)
323242: Manual Traverse (Power Turntable)
323240: Power Traverse (Power Turntable)
3232101: Manual Traverse Quick Curve
323177: Power X/Y
323149: Power Traverse w/ RTC

C-625: Lift Up to 625 lb (284 kg)
323117: Manual Traverse (Docking Station)
323417: Manual Traverse (OMNI Charging)
323127: Power Traverse (Docking Station)
323427: Power Traverse (OMNI Charging)
323246: Manual Traverse (Power Turntable)
323244: Power Traverse (Power Turntable)
323118: Manual Traverse Quick Curve
323137: Power X/Y
323126: Power Traverse w/ RTC

C-800: Lift Up to 800 lb (363 kg)
329180: Manual Traverse (Docking Station)
329181: Manual Traverse (OMNI Charging)
329190: Power Traverse (Docking Station)
329191: Power Traverse (OMNI Charging)
329184: Manual Traverse Quick Curve
329187: Power X/Y

C-1000: Lift Up to 1000 lb (454 kg)
329100: Manual Traverse (Docking Station)
329101: Manual Traverse (OMNI Charging)
329150: Power Traverse (Docking Station)
329151: Power Traverse (OMNI Charging)
329137: Power X/Y
329126: Power Traverse w/ RTC



A-Series Specifications

Motors

Lift Motor: 24 VDC
Power Traverse: 24 VDC (Opt)
X-Y Traverse: 24 VDC (Opt)

Safe Working Load (SWL)

A-450 / AP-450: 450 lb (204 kg)
A-625: 625 lb (284 kg)

Dimensions (L x W x H)

A-450 / A-625:
13.7 x 8.9 x 6.8 in
(347 x 227 x 172 mm)
AP-450:
14 x 8.2 x 7.5 in
(365 x 209 x 190 mm)

Unit Weight

A-450: 21-23.5 lb (9.5-10.6 kg)
A-625: 21-23.5 lb (9.5-10.6 kg)
AP-450: 12.2 lb (5.5 kg)

Lift Case

Flame Retardant ABS
with IPx22 rating
(IPx22 rating A-450 / A-625 only)

Safety

Emergency Stop
Emergency Lowering
Low Battery

Standards

IEC 60601-1:2005/A1:2012
IEC 60601-1-6:2010/A1:2013
IEC 60601-1-11:2015
IEC 62366:2007/A1:2014
ISO 10535:2006
IEC 60601-1-2:2014 (Ed 4.0)

Hand Control

Digital
IPx6 and IPx7 Rating

Service Life

A-450 / A-625: 10 years or 22,500 Cycles
AP-450: 10 Years or 16,000 Cycles

Rated Performance

A-450 / AP-450: 50-60 lifts at Max Load
A-625: 30-40 lifts at Max Load

Maximum Sound Level

50 dB

Batteries

A-450 / A-625:
AH, Sealed Lead Acid
24 VDC (2 x 12 VDC)
5.0 AH
AP-450:
NiMH - Nickel Metal Hydride
24 VDC (20 x 1.2 VDC)
4.0 AH

Charger Model

Soneil, PS2403SRM26

Charger Input

100-240 VAC 0.5 Amps, 50-60 Hz

Charge Output

24 VDC, 1.33 Amps

Lifting Range

A-450 / A-625: Up to 96 in (2438 mm)
AP-450: Up to 77 in (1960 mm)

Duty Cycle

1 Min "On"
9 Mins "Off"



Part Numbers



A-450: Lift Up to 450 lb (204 kg)

324200: Manual Traverse
324202: Manual Traverse w/ Load Cell and Wi-Fi
324204: Power Traverse w/ RTC
324206: Power Traverse w/ RTC, Load Cell and Wi-Fi

A-625: Lift Up to 625 lb (283 kg)

324201: Manual Traverse
324203: Manual Traverse w/ Load Cell and Wi-Fi
324205: Power Traverse w/ RTC
324207: Power Traverse w/ RTC, Load Cell and Wi-Fi

AP-450: Lift Up to 204 kg (450 lb)

303060: Portable Ceiling Lift

We're Trusted.

Over 275,000 ceiling lift installations across North America.

We're Experts.

Handicare handles the installation and provides **FREE on-site training** for your staff.

Are you ready to take the next step in safe patient handling?

Call 1-888-637-8155 or visit www.handicareusa.com / handicare.ca

HANDICARE 10888 Metro Court, St. Louis, MO 63043

Toll Free: 866.891.6502 | Fax: 314.692.7858 | customerservice.northamerica@handicare.com | www.handicareusa.com



HANDICARE 81 Romina Drive, Concord, ON L4K 4Z9

Toll Free: 877.304.5438 | Fax: 416.260.0256 | customerservice.canada@handicare.com | www.handicare.ca